



OPTOCORE



Operating Manual for OPTOCORE M-Series

OPTICAL/COAXIAL MADI SWITCH WITH ETHERNET
Optical Digital Network Device

© Copyright 2017 All rights reserved

OPTOCORE GmbH
Lohenstr. 8
82166 Munich-Gräfelfing
Germany

M-Series

Operating Manual
Rev. 1.2

Page intentionally left blank.

Important Safety Instructions

- Please read this manual carefully.
- Please keep this operating manual in a safe place.
- Heed all warnings.
- Follow all instructions.
- This device may only be used in accordance to the information provided in this operating manual. Ensure that all recommendations, especially the safety recommendations as detailed in this operating manual, are followed before and during the usage of the device.
- Do not use this device near water, for example, in humid or damp rooms.
- Clean only with a dry cloth.
- Do not block or cover any ventilation slits. Install the device in accordance with the operating manual.
- Do not install or place the device near any heat source such as radiators, power-amplifiers, or any other heat producing equipment.
- Protect the power cord from being stepped on, crushed, pinched or damaged in any other way. Pay special attention to plugs and sockets of the device.
- Never switch on power amplifiers before the complete system is stable and the level meters of the OPTOCORE CONTROL software indicate a normal level.
- Do not place this device on an unstable table, tripod, cart, etc. The device may fall, causing serious damage to the device.
- The device can be disconnected from the power supply by pulling the plug. These must be freely accessible at all times. The device should be disconnected during lightning storms or when unused for long periods of time.
- The device must be grounded; any disconnection of the grounding is not permitted.
- The internal components of the switched-mode power supplies operate at very high voltages. Coming into contact with them can lead to considerable electric shock, which may result in death.
- Only use attachments specified by the manufacturer.
- This device contains no user serviceable parts: only refer to authorized, qualified service personnel for any servicing.
- Your warranty will be voided if you tamper with the internal components.

Purchaser Information

- **Operating Manual**

Please read this manual. If you call for technical support, we will assume that you have already done so. Study the operating manual carefully in order to familiarise yourself with the device and its operation. The operating manual contains important information on proper use of the device.

It cannot be guaranteed that this operating manual will not contain typographical mistakes or misprints. The operating manual is regularly revised and updated.

Modifications, which serve the purpose of technical improvement of the device, may be carried out without prior notification.

- **Transport and Shipping**

Always ensure careful handling of the device. The device should be transported and shipped in shock-absorbing transport cases. If these are not available, we recommend well-padded packaging such as the coated carton in which the device was delivered.

We strongly advise against the use of light weight flight-cases without shock-absorbing rack-in-rack mounting.

- **Environments**

This device can be used in E1, E2, E3, E4, or E5 environments (as listed below) according to the harmonized European standards EN55103-1 and EN55103-2 "Electromagnetic compatibility – Product family standard for audio, video and audio-visual and entertainment lighting control apparatus for professional use"

E1-Residential

E2-Commercial and light industrial

E3-Urban outdoors

E4-Controlled EMC environment e.g. broadcast and TV-studio

E5-Heavy industry

The product is intended for the use in moderate climate.

- **Ventilation**

Do not block or cover any ventilation openings. Install the device in accordance to the operating manual. Allow for sufficient space around the units (at least 200 mm \cong 7,87" free space behind the rear-panel of the device) and make sure to allow for air circulation near the ventilation openings on both sides of the device. Keep the rear of the rack open during operation. Do not operate the device close to heat emitting equipment, such as power-amplifiers. Leave sufficient space (minimum ½ RU) between the device and any heat emitting devices housed in the same rack.

M-Series devices may be placed on top or beneath other Optocore products, except a DD32E, without additional space for up to 4 adjacent rack spaces.

Please note:

Do not populate more than 4 adjacent rack spaces with Optocore devices.

Maintain 1RU of empty space between each 4 RU of Optocore devices.

Keep the equipment rack open during operation.

Ensure air circulation around the devices.

Maintain at least 200mm (~8") clearance behind the rear panel of the devices.

- **Water and Moisture etc.**

To prevent fire or shock hazard do not expose the device to direct sunlight, dust, water, or rain during operation or storage.

- **Cleaning**

Only use a dry linen cloth to clean the device. If the unit is very dirty, moisten a cloth using a little water and a small amount of household detergent. Never use cleansing agents containing solvents to clean the device.

- **Operating and Storage Temperature**

Operating temperature: $-20^{\circ}\text{C} \dots 50^{\circ}\text{C} \equiv -4^{\circ}\text{F} \dots 122^{\circ}\text{F}$; ensure proper ventilation

Storage temperature: $-20^{\circ}\text{C} \dots 60^{\circ}\text{C} \equiv -4^{\circ}\text{F} \dots 140^{\circ}\text{F}$

- **Power Supply**

The device can be disconnected from the power supply by unplugging the power cord. The power cords must be freely accessible at all times. The device should be disconnected during lightning storms or when the device is unused for a long period of time.

Important:

The switched-mode power supplies operate at very high voltages.

Coming into contact with the power supplies can lead to considerable electric shock, which may result in death.

Never disconnect the main plug by pulling the cable, always pull the plug itself.

Power-supply cords should be routed in such a way that they are not likely to be walked on, crushed, pinched or damaged in any other way. Pay special attention to the plugs and the sockets of the device.

Important:

A damaged power cable must be replaced immediately.

The device must be grounded. Disconnecting the ground is strictly prohibited. Ensure that the device is always grounded using the power connector.

Do not cover the ground connection of the power connector with any kind of insulation material!

- **Fuse**

There is no fuse in the device. The power supplies contain circuitry that protects the device from overload.

- **Lightning**

For additional protection of this device during lightning storms or when it is left unattended and unused for a long period of time, disconnect the power cord. This will prevent damage to the device due to lightning and power line surges. Disconnection from the mains power supply is only possible by disconnecting the power plug from the main socket.

- **Eye Safety**

This product is a Laser Class 1 product. It complies with IEC 60825-1, FDA 21 CFR 1040.10, and 1040.11.

- **External objects and/or liquids with the device**

Never push objects of any kind into the device through openings in the casing. They may come into contact with dangerous voltage points or short out parts that could result in fire or electric shock. Never spill liquid of any kind on the device.

- **Cables and Accessories**

Only use attachments that are specified by the manufacturer of the device.

Use high quality, properly terminated, cables to connect the device. The device should only be used with optical fibre cables that are specified for use with the devices' optical transceivers and within the specified power budget of the optical transceivers. When not in use, ensure that the optical connectors on the device and the optical fibre cables are covered with the provided caps.

Do not place this device on an unstable table, tripod, cart, etc. The device may fall, which can cause injury and serious damage to the device. Any mounting of the device should follow the manufacturer's instructions, and should use mounting accessories recommended by the manufacturer of the device.

- **Servicing**

Do not attempt to service this device yourself.

The device contains no user serviceable parts, components or controls. The operation of an opened device is not permitted. Such operation can lead to damage of the device's components due to lack of air-flow through the device.

The device may not be serviced, altered or modified without authorization from Optocore or an Optocore authorized distributor / dealer. Only qualified service personnel may carry out repair and maintenance work on the device. The warranty of the device will be voided if any unauthorized maintenance or repair work has been carried out..

CE/FCC-Conformity

This document confirms that the M-Series devices (M12-OPT, M12-BNC, M12-OPT/BNC, M8-OPT, M8-BNC) bearing the CE (Communauté Européenne) label meets all requirements in the EMC directive 2004/108/EG laid down by the Member States Council for adjustment of legal requirements. Furthermore the product complies with the rules and regulations of the low-voltage directive 2006/95/EG and the Restriction of Hazardous Substances Recast Directive 2011/65/EU (RoHS 2). This product bearing the CE label complies with the following standards, ratified by CENELEC (Comité Européen de Normalisation Electrotechnique):

Electromagnetic compatibility – Product family standard for audio, video, audio-visual and entertainment lighting control apparatus for professional use

EN 55103-1, Emission

EN 55103-2, Immunity

EN 60065, Safety requirements

FCC notice

This device complies with Part 15 of the FCC Rules. Operation is subject to the following two conditions:

- (1) this device may not cause harmful interference, and
- (2) this device must accept any interference received, including interference that may cause undesired operation.

NOTE: This equipment has been tested and found to comply with the limits for a Class A digital device, pursuant to Part 15 of the FCC rules. These limits are designed to provide reasonable protection against harmful interference when the equipment is operated in a commercial environment. This equipment generates, uses and can radiate radio frequency energy and, if not installed and used in accordance with the instruction manual, may cause harmful interference to radio communication. Operation of this equipment in a residential area is likely to cause harmful interference, in which case you will be required to correct the interference at his own expense.

Changes or modifications not expressly approved by Optocore GmbH could void the user's authority to operate this equipment.

Industry Canada Compliance Statement

This Class[A] digital device complies with Canadian ICES-003.

Avis de conformité à la réglementation d'Industrie Canada

Cet appareil numérique de la class[A] est conforme à la norme NMB-003 du Canada

The authorised declaration and compatibility certification lies with the manufacturer and can be viewed on request. Responsible as manufacturer is:

OPTOCORE GmbH, Lohenstr. 8, 82166 Munich-Gräfelfing, Germany

represented by Marc Brunke, Managing Director

N.B. The awarding of the CE label confirms the compliance with legal directives issued for the manufacturer and marketing of electronic and electrical devices. As such the CE label is not a "seal of quality" but rather proof that the device bearing the CE label conforms with the electromagnetic compatibility standards laid down in the above named testing regulations.

Munich, 11.12.2013



Marc Brunke

Page intentionally left blank.

M-Series – OPTICAL/COAXIAL MADI SWITCHES WITH ETHERNET

Table of Contents

Important Safety Instructions.....	3
Purchaser Information	4
CE/FCC-Conformity	7
Device Description	10
Front Panel.....	12
Rear Panel	14
Device Details	16
MADI Ports.....	16
Optocore Fibre Optic Connection	16
SANE Ports.....	16
RS485 Auxiliary Ports.....	16
Word Clock	16
Ethernet Ports.....	16
Power Supply.....	17
Transmission Delay	17
Control.....	17
Optocore bandwidth allocation.....	17
SANE bandwidth allocation.....	18
Connectors and Cables.....	19
Optical MADI Ports	19
Coaxial MADI Ports.....	19
Optical Connection.....	19
SANE Ports.....	19
Principal and Auxiliary Ports	19
RS232-Connection.....	19
Connector Hood Quality.....	19
USB-Connection	19
Word Clock-Connection	19
Mains-Connection	19
Standalone Application Example	20
Network Examples	21
Example 1	21
Example 2	22
Technical Specifications.....	25
Dimensions and Weight	26
Warranty and Liability.....	27
Shipping Contents.....	28
Company Information.....	28

Device Description

Congratulations on your purchase of a M-Series device standalone MADI switch with Optical Digital Network Interface with Cat5 based SANE, Ethernet and data interfaces. The M-Series device manual will quickly demonstrate the advantages of the device and help to ease your day-to-day workload in a professional audio-visual environment.

The M-Series device is a standalone MADI switch, which can be networked and integrated with the OPTICAL OPTOCORE- and CAT5 SANE DIGITAL NETWORK SYSTEMS. The unit provides up to eight MADI input and MADI output ports, offering up to 512 input and 512 output digital audio channels on coaxial and/or fiber MADI. Each MADI port can be adjusted to handle different formats according to the AES standards (56 or 64-channel MADI). Device can operate in sample rates up to 192 kHz (sample rates above 96 kHz are available upon request). The device is perfectly suitable for 3rd party equipment integration, especially with Soundcraft, Studer, Lawo, SSL digital consoles.

Please note:

Fiber MADI ports on M-Series devices are equipped with special fiber transceivers which support both singlemode and multimode connectivity. Please use multimode cable in each case

The M12 can be equipped with any combination of two MADI boards – 4 dual-port coaxial MADI board or 4 duplex optical MADI board. As a result M12 switch can be delivered in 3 different flavors – M12-OPT (8 duplex Optical MADI ports), M12-BNC (8 dual coaxial MADI ports) or M12-OPT/BNC (4 duplex optical MADI and 4 dual coaxial MADI ports).

The M8 can be equipped with one of MADI board - 4 dual-port coaxial MADI board or 4 duplex optical MADI board. M8 switch can be delivered in 2 options – M8-OPT (4 duplex Optical MADI ports) or M8-BNC (4 dual coaxial MADI ports).

Redundant fibre Optocore connections can be established using two provided SFP-based LC multimode or singlemode optical LINK-interfaces. The dual redundant ring structure provides maximum safety in a network with an outstanding low latency. It facilitates the use of the advantages of fibre optical transmission in all sorts of temporary and permanent applications, especially when long distance connections and high-quality audio are required.

The M-Series device enables connectivity to the SANE network via RJ45 ports. It is possible to use SANE as a Cat5 based cost-efficient extension to the optical core system. SANE ports may be used as point-to-point MADI over Cat5 or as a bridge interface between SANE and OPTOCORE, providing in total up to 128 input and 128 output additional channels.

Two built-in Ethernet ports can be used to establish 100Mbit Ethernet LAN through the OPTOCORE and SANE networks. The M-Series device together with R-Series devices behaves like one 100Mbit Ethernet switch. SANE ports can be used for Ethernet transport as well, so up to four ports can be used to provide Local Ethernet connection via single M-Series device.

The M-Series device provides both word clock input and output. Additionally four RS485 ports allow the transport of a wide range of standards such as RS422, DMX, MIDI, and CAN-Bus (bi-directional, requires special firmware version). In addition to the audio signals, video and data signals are transmitted through the common fibre connection. The dual power supply unit, with automatic switchover, permits a redundant power supply and safeguards against malfunctions in the event of a power supply failure.

The M-Series devices are the perfect I/O interfaces for a wide range of professional audio devices with MADI inputs and outputs such as digital consoles and I/O systems. The high number of channels exchanged by one M-Series device makes it the ideal and the most cost effective interface for digital console systems as well as a perfect central device offering individual channel routing feature. The number of input channels can be defined in groups of eight by the OPTOCORE CONTROL software. Only this number of channels is allocated for transmission via fibre optical connection. This keeps the system highly flexible in order to build the network exactly suiting the application needs. The M-series device, for example, can transmit 128 channels to a digital console system from various Optocore devices such as DD32R-FX, X6R-FX or V3R-TP. If only eight return channels from the console are required, only those eight channels instead of 512/256 inputs can be received at

the M-Series device and transmitted via fibre optical connection, leaving the other channels to be shared with the other network devices. Networks with M-Series devices and other Optocore allow the transport of a huge amount of digital signals, e.g. 768 audio channels with a sample rate of 48 kHz, 32 RS485 channels and three video channels. Depending on the type of fibre optic transceiver, distances from 700 m up to 120 km can be covered.

The dual optical interfaces with data transfer rates up to 2 Gbps are equipped with LC-connectors, commonly used and absolutely reliable in permanent installations. For rough applications such as touring and live productions the 1U OptoCon panel, with rugged and secure fibre optic connectors can be added to the rack.

All Optocore devices are designed and built using the latest programmable microprocessors and FPGA (field programmable gate array) logic circuitry. This allows the devices internal logic to be updated, in the field, ensuring a continual state-of-the-art device.

Optocore devices, and complete networks, are configured and operated using the OPTOCORE CONTROL software. The software provides access to all configuration parameters and controls needed to operate the system, including: naming channels, setting gains and phantom power, routing as well as recall and capture of partial or full system configurations. The software can be operated offline as well as online with level meters for all channels on the network.

Front Panel

M12-OPT / M12-BNC / M12-OPT/BNC

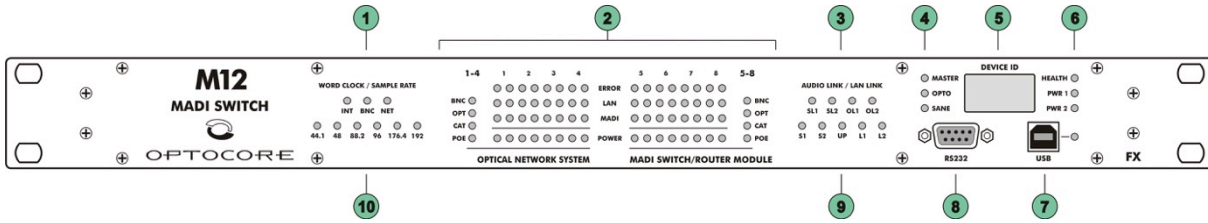

M8-OPT / M8-BNC

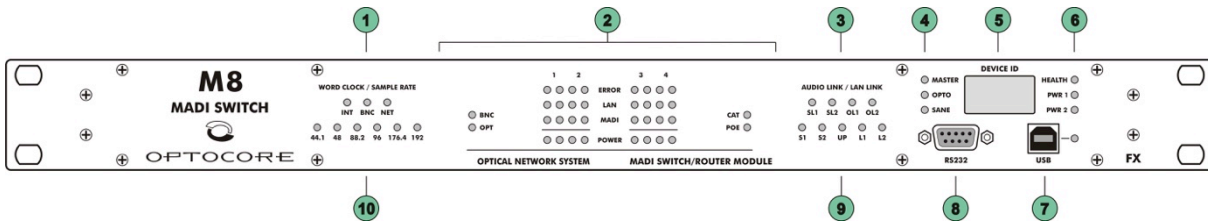

- 1 Word Clock LED:** Indicates the selected word clock source:
 INT: Internal word clock – The device is a system master
 BNC: External word clock via BNC WC Input
 NET: Word clock received from network

- 2 Status LEDs of 8 MADI Ports (4 MADI Ports for M8) :**

 - BNC:** Four Dual Coaxial MADI Board
 - OPT:** Four Bi-Directional Optical SC Board
 - CAT:** Future option
 - POE:** Future option

 - ERROR:** Red: Error with incoming MADI signal
 - LAN:** Yellow: Ethernet communication present
 - MADI:** Green: MADI Signal present
 - POWER:** Future option

- 3 AUDIO LINK:** Indicates the audio link status

 - SL1:** Communication is established via SANE 1 (rear panel)
 - SL2:** Communication is established via SANE 2 (rear panel)
 - OL1:** Communication is established via Optocore LINK 1 (rear panel)
 - OL2:** Communication is established via Optocore LINK 2 (rear panel)

- 4 System status**

 - Master LED:** Indicates the Word Clock Master unit
 - OPTO LED:** Optocore communication is established
 - SANE LED:** SANE communication is established

- 5 Device ID Display:** Indicates the identification number of the device

- 6 HEALTH LED:** Green: Power supply to the device works, temperature is below the limit
PWR 1 LED: Power supply 1 is working correctly
PWR 2 LED: Power supply 2 is working correctly

- 7** **USB plug and LED:** USB connection for remote control and update via PC
Green: Indicates data activity
- 8** **RS232 plug:** D-Sub-9 RS232 connection for remote control and update via PC
- 9** **LAN LINK:** Indicates the Ethernet link status
- S1:** Ethernet communication is established via SANE 1 (rear panel)
S2: Ethernet communication is established via SANE 2 (rear panel)
UP: There is other device with physical Ethernet port enabled on the network
L1: Ethernet communication is established via LAN 1 (rear panel)
L2: Ethernet communication is established via LAN 2 (rear panel)
- 10** **Sample Rate LED:** Yellow: 44,1 / 48 / 88,2 / 96 / 176,4 / 192 kHz

Rear Panel

M12-OPT

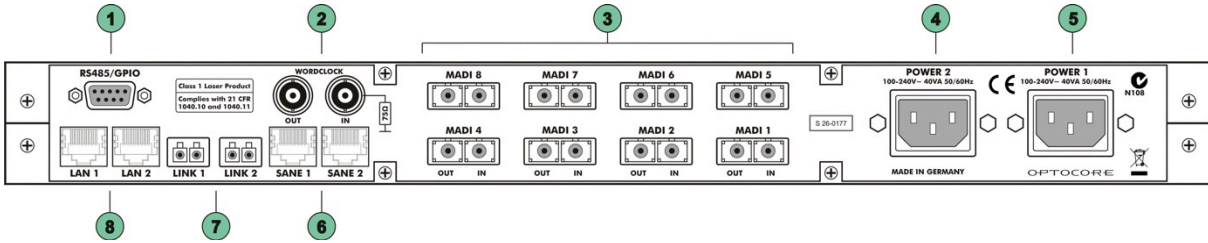

M12-BNC

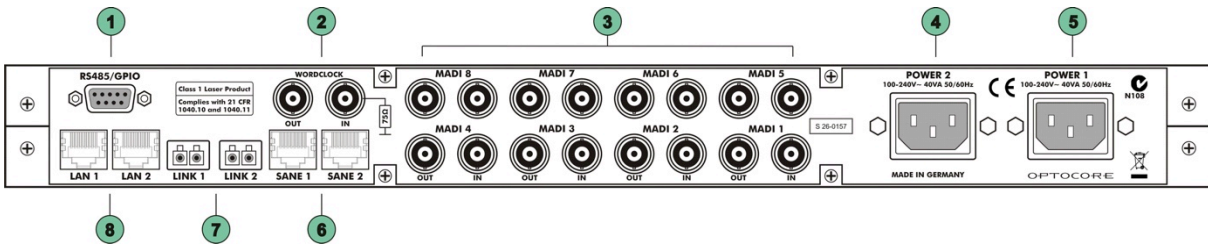

M12-OPT/BNC

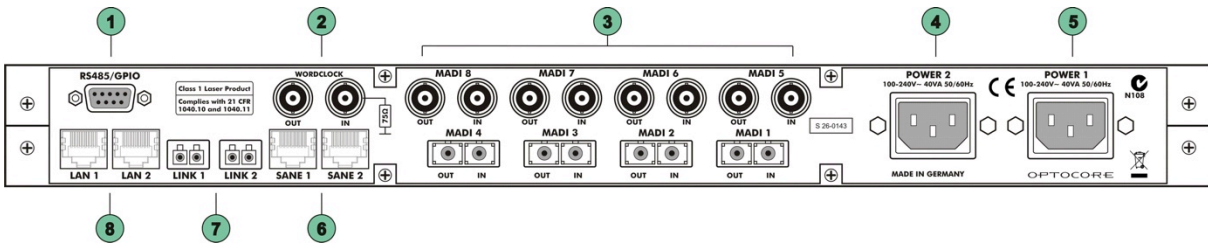

M8-OPT

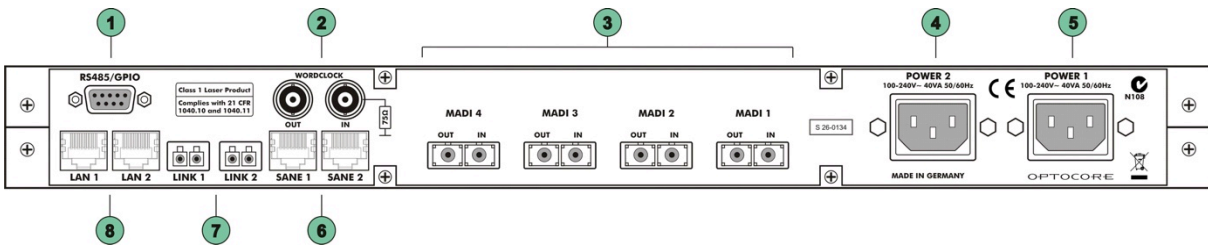

M8-BNC

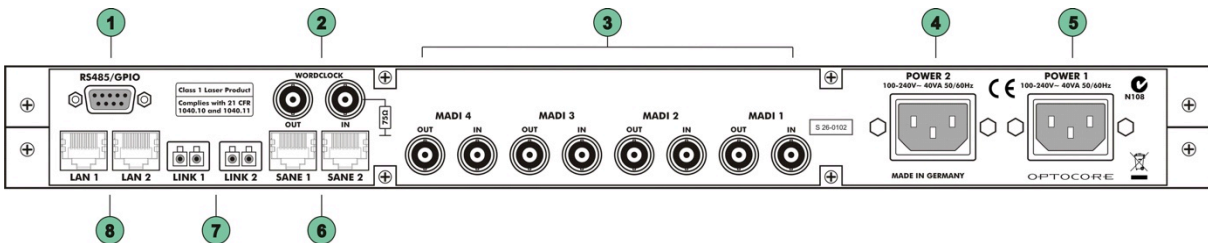

- 1
RS485: 4 x RS485/RS422 (D-Sub-9) auxiliary port for data transmission
- 2
Word Clock IN: BNC Word clock input allowing synchronization of Optocore devices/network from an external word clock source

Word Clock OUT: BNC Word clock output for synchronization of external devices
- 3
MADI PORTS:
 - M12-OPT** 8 x SC multi/single-mode optical MADI inputs and 8 x SC multi/single-mode optical MADI outputs
 - M12-BNC** 8 x coaxial BNC MADI inputs and 8 x coaxial BNC MADI outputs
 - M12-OPT/BNC** 4 x SC multi/single-mode optical MADI inputs and 4 x SC multi/single-mode optical MADI outputs
4 x coaxial BNC MADI inputs and 4 x coaxial BNC MADI outputs
 - M8-OPT** 4 x SC multi/single-mode optical MADI inputs and 4 x SC multi/single-mode optical MADI outputs
 - M8-BNC** 4 x coaxial BNC MADI inputs and 4 x coaxial BNC MADI outputs
- 4
POWER 2: Mains input for power supply 2 (100 ... 240 V)
- 5
POWER 1: Mains input for power supply 1 (100 ... 240 V)
- 6
SANE 1: SANE RJ-45 interface for data transmission + 100 Mbit Ethernet
SANE 2: SANE RJ-45 interface for data transmission + 100 Mbit Ethernet
- 7
LINK 1: Full-duplex, full bandwidth LC-type optical interface for Optocore transmission (SFP multimode transceiver included, singlemode transceiver option available on demand)

LINK 2: Full-duplex, full bandwidth LC-type optical interface for Optocore transmission (SFP multimode transceiver included, singlemode transceiver option available on demand)
- 8
LAN 1: 100 Mbit RJ-45 Ethernet interface
LAN 2: 100 Mbit RJ-45 Ethernet interface

Device Details

MADI Ports

MADI (Multichannel Audio Digital Interface) was first standardized by the AES10-1991 for the transmission of 56 digital audio channels in one frame. The revision AES10-2003 enhanced the number of channels to maximal 64 digital channels. The M-Series supports the formats according to both standards. If an external device cannot handle a 64 channel MADI frame the ports can be set to the 'older' AES10 standard with OPTOCORE CONTROL.

The M-Series devices are equipped with up to eight MADI input ports and eight MADI output ports, each transmitting or receiving up to 64 audio channels. This amounts to a total number of up to 512 input channels and 512 output channels per device. The interfaces are SC multi/singlemode for optical connections and/or BNC connectors.

The M-Series device is the perfect main MADI hub unit for a wide range of professional audio devices with MADI inputs and outputs such as digital consoles, DAW, playback devices and professional broadcast units. The huge amount of channels exchanged by one M-Series device makes it the ideal and the most cost effective interface for digital console systems as well as a perfect central device offering individual channel routing feature.

The number of input and output channels exchanged at each port and transmitted on the fibre optical connection can be defined in the OPTOCORE CONTROL software (for details refer to OPTOCORE CONTROL SOFTWARE Manual). This keeps the matrix easy-to-handle and the quantity of channels per device in the network flexible.

Optocore Fibre Optic Connection

The device is equipped with the Optocore FX communication module. The OPTOCORE ® OPTICAL DIGITAL NETWORK SYSTEM utilizes Time Division Multiplex technology (TDM) with a Fibre Channel based 8B10B-NRZI-coding. Static time slots guarantee a synchronous transmission of all channels, at all times, without the use of dynamic bandwidth or latency. All signals connected to the intercom, audio, video, word clock and auxiliary ports of the device are transmitted simultaneously on one fibre while the second fibre of the LINK-Interface receives data from the network. The second LINK-Interface pair is identical to the first one, and can optionally be used for network redundancy.

SANE Ports

The device is equipped with two RJ45 200MBit SANE Ports, capable of transmitting 64 channels of synchronous audio and 100MBit Ethernet. SANE 2 port is compatible with MADI over Cat protocol.

RS485 Auxiliary Ports

The auxiliary ports provide four RS485 interfaces to establish a maximum of four half-duplex or two full-duplex connections between the devices. A wide range of bi-directional and unidirectional standards can be connected, such as RS485, CAN-Bus (bi-directional, requires special firmware version), or RS422, DMX, MIDI (unidirectional). The ports automatically sense whether they are sending or receiving control data.

The ports and their destinations are configured in the OPTOCORE CONTROL software..

Word Clock

Devices with Optocore/SANE modules are equipped with an internal, high quality, low jitter clock generator as well as Word Clock inputs and outputs. Any device on the network can act as the master of the network and pass Word Clock to networked Optocore/SANE devices.

The internal/networked Word Clock is available at the Word Clock output connector of each device on the network to synchronize non-networked devices.

In standalone network configurations external synchronization is not required.

The Word Clock input termination can be switched on using the OPTOCORE CONTROL software's Local Settings. External termination is not required to avoid cable reflections.

Word Clock master negotiation after any Word Clock source failure is done automatically.

Ethernet Ports

M-Series devices supports Optocore and SANE Ethernet transport. Two LAN ports interface with all other LAN and SANE/LAN ports in the Optocore and SANE Network creating a large unmanaged virtual 100Mbit Ethernet switch.

Power Supply

The device is equipped with two power inputs and power supply units. If one power supply fails, due to malfunction of the feeding power line or the power supply unit itself, the device will automatically switch over to the other power supply unit. In order to make the power supply redundant, both power inputs must be connected to the mains supply, if possible to different phases, power supply systems, or even better, one of them to an uninterrupted power supply (UPS).

The power supply units operate with mains voltage of 100 ... 240 V and frequency of 50 ... 60 Hz. Thus the device can be used throughout the world without any modifications or transformers.

Important:

The switched-mode power supplies operate at very high voltages.

Coming into contact with the power supplies can lead to considerable electric shock, which may result in death.

To prevent electric shock, do not remove any covers of the device.

Transmission Delay

The Optocore system delay including the matrix is fixed to 41,6 μ s @ 48 kHz for all channels. The additional transport delay per Optocore unit (<200 ns) in the network is insignificant in comparison. Overall system delay is dependent on the converters used and the length of network cables in the system. Assuming 'normal' cable lengths of <700 m per link, the additional delay is considered marginal.

The transmission delay is constant between any points in the network.

Control

All system and device parameters are configured using the OPTOCORE CONTROL software. The system can be configured and controlled centrally, over the Optocore network, with the exception of the initial configuration of the unique identifier (ID) of the device.

The OPTOCORE CONTROL software is capable of running multiple instances on the same PC or by using the OPTOCORE CONTROL software's Client/Server mode.

Please note:

Please refer to the Optocore Quick Start Guide for the basic system configuration and setup.

For more detailed setup please refer to the Optocore Software Manual

Optocore bandwidth allocation

The standard bandwidth allocation of an Optocore network is as follows:

Audio	256 Channels @ 48 kHz – 1 Gbit network 768 Channels @ 48 kHz – 2 Gbit network
RS485 Data	32 Channels
Video	3 CVBS Video Channels *
Ethernet	100 MBit Fast Ethernet *

* If the network is used for transport of Ethernet compatible data the capacity is reduced to one CVBS video channel plus 100 Mb/s Fast Ethernet.

Please note:

Optocore R-Series devices equipped with 2Gbit fibre transceivers are required for 2Gbit network operation.

SANE bandwidth allocation

The standard bandwidth allocation of a SANE link is as follows:

Audio	64 Channels @ 48 KHz
Ethernet	100 MBit Fast Ethernet

Connectors and Cables

Optical MADI Ports

The MADI-interfaces are equipped with SC multimode optical connectors. Standard SC cables are perfectly suitable for interconnection of devices. It is recommended to use multimode cable for MADI connectivity. The MADI transceiver provided by Optocore supports both multi-mode and single-mode connectivity as long as the multimode cable is used.

Coaxial MADI Ports

The MADI-interfaces are equipped with standard BNC 75 Ω - connectors. The applied coax cables should have the 75 Ω characteristic impedance.

Optical Connection

Multimode transceivers connected using a 50 μm OM3 fibre cable can be used for applications requiring cable lengths of up to 700 m (worst case).

Single mode transceivers connected using a 9 μm fibre cable can be used for applications requiring cable lengths of up to 70 km (worst case).

The total optical loss should be less than 6dB between transceivers.

For portable applications, such as touring and other temporary installations, ruggedized HMA Expanded Beam Connectors, mounted on 1 RU panels and portable cables on cable drums are available. Please refer to the Product Brochure available at www.optocore.com.

SANE Ports

Use standard, fully wired, twisted pair cable (Cat 5, Cat 5e, Cat 6) terminated with RJ-45 connectors. SANE utilizes all four pairs of the Cat 5 cable, two pairs for standard Ethernet transmission and two pairs for the SANE synchronous audio transport. A SANE cable shall not exceed a total cable distance of 100 m..

Principal and Auxiliary Ports

Each of the four channels requires a shielded twisted pair cable.

If two or more channels are wired to the same cable, a common braided shield should enclose the pairs.

RS232-Connection

Use a standard shielded RS232 cable.

Connector Hood Quality

Locking screws for D-Sub connectors should be compatible with 4-40 UNC. Care should be taken in selecting the right type of connector hoods in order to fulfil the requirements of EMI-radiation directives. Full metal connector hoods should be used, approved acc. to VDE 0871, FCC 20780 and EMC directive 2004/108/EG, providing attenuation > 40 dB between 30 MHz up to 1 GHz. The shield of the cable should have contact to the connector hood.

USB-Connection

Use a USB-A to USB-B cable between PC and Optocore device.

LAN-Connection

Use standard twisted-pair-cable (Cat-5, Cat-6) with RJ-45 connectors.

Word Clock-Connection

Use 75 Ω -coaxial-cable with BNC-connectors.

Mains-Connection

Standard power cords with IEC C13 connectors.

Standalone Application Example

An application example below displays the benefits of M12-OPT/BNC working as a standalone MADi router device. M12-OPT/BNC is equipped with two MADi board each with four bidirectional MADi ports. Four of them are coaxial, the rest four are optical with SC connectors. Video Router, DSP Processor, Playback System and Intercom Matrix are connected to the optical MADi ports while, two OB VAns, Digital Audio Workstation and Digital Mixing Console are connected to the BNC MADi ports.

OPTOCORE CONTROL SOFTWARE controls single channel routing, channel naming as well as quick stream switching using Macros. Each channel can be routed from any input to any output of the MADi switch, this also enable passive input to multiple outputs splitting. Each MADi port can be adjusted individually as a ASE10-1991 or AES10-2003 with 56 or 64 I/O channels. RS232, USB or LAN can be used for a configuration connection. M12 has a build in Fast Ethernet four-port switch.

As an addition M12 device is equipped with two power supplies with automatic switchover mechanism to prevent power malfunction.

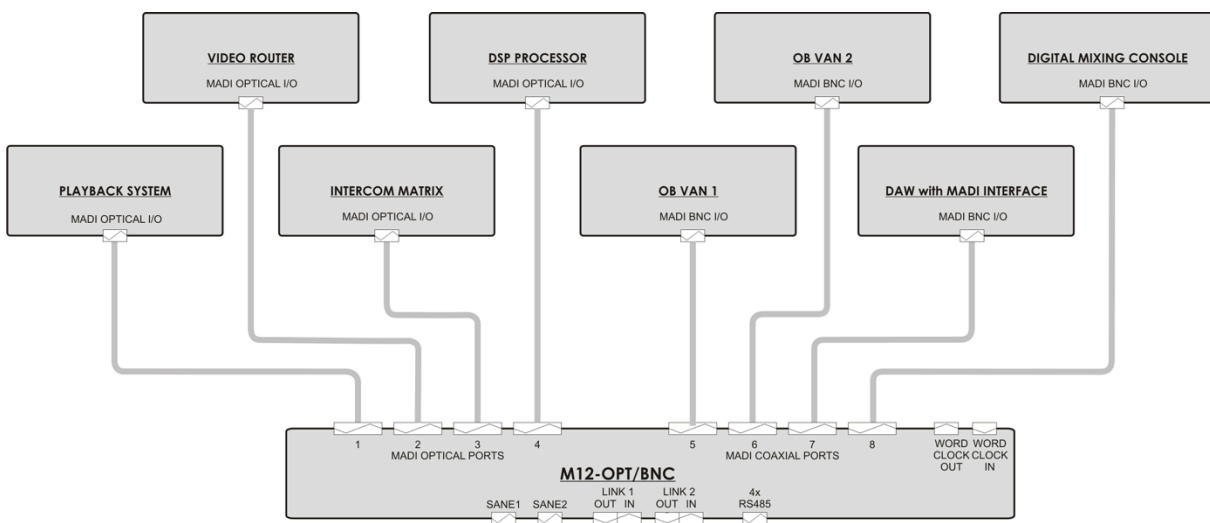

Fig. 1: A standalone application example of M12-OPT/BNC device

Network Application Examples

Example 1

M8-OPT devices can be used in a redundant fiber optic network. It can be used as a redundant MADI extender for 3rd party consoles to transport all audio signals and control data between stage unit and FOH local equipment. Drawings below present configurations with LAWO and Soundcraft consoles in the one network. As an additional unique feature audio channels from Dallis frame can be splitted to Soundcraft system and from Soundcraft Stage Rack to LAWO HD-Core system. For a detailed information regarding 3rd party manufacturers transport please refer to the proper Integration Guide documents.

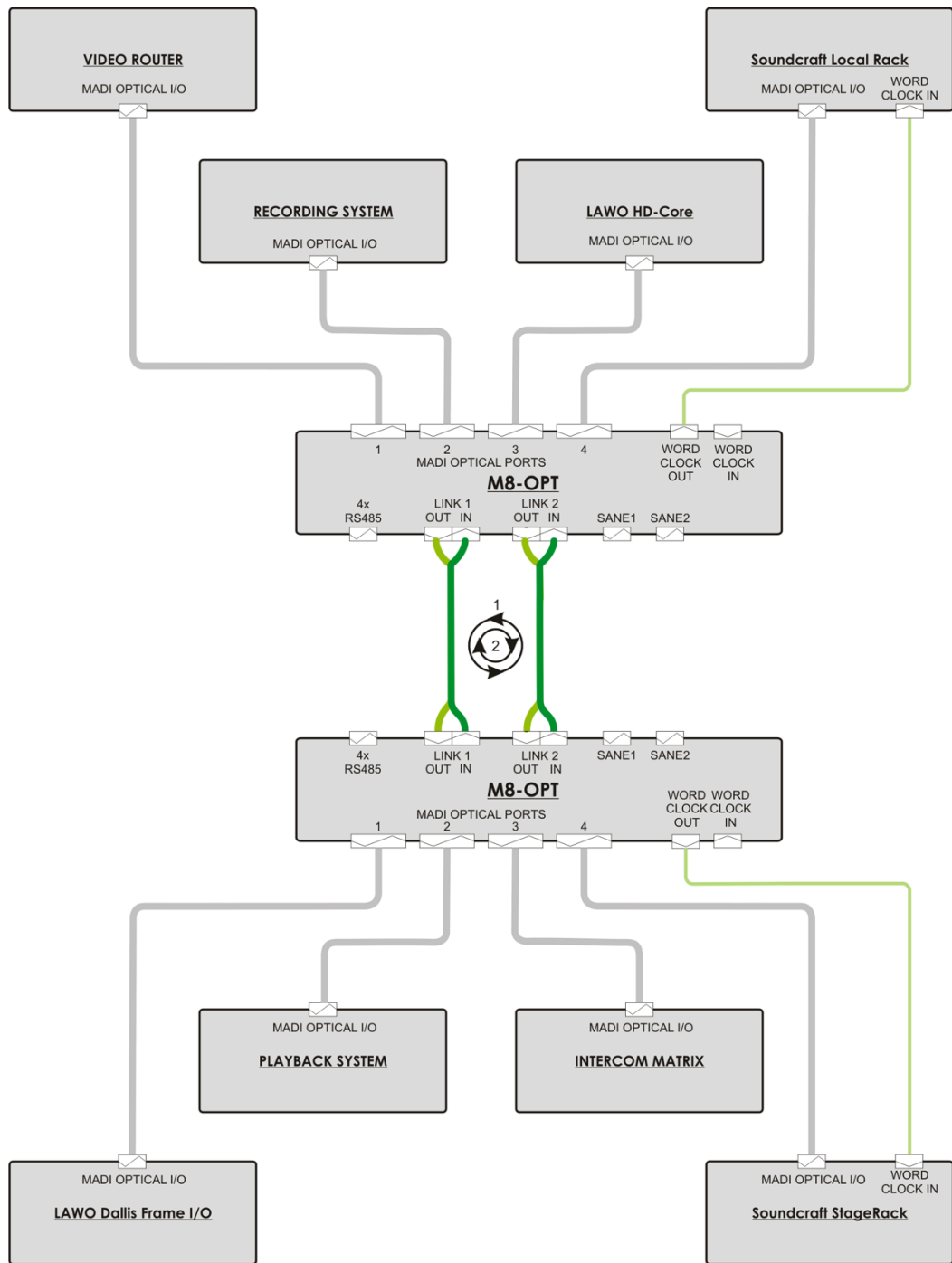

Fig. 2: Redundant network with two M8-OPT in a configuration with Lawo and Soundcraft

Example 2

Second example shows how to use OPTOCORE devices as a stage I/O for different mixing consoles. Up to four Emulation Modes (which enable the control of Optocore preamps directly from the console) are available in the system and up to two devices connected with M-Series device allowing remote preamp control from Soundcraft, Studer, Lawo, SSL and Yamaha. X6R-DualMic devices with 8 dual microphone preamps are used in this example. It enables a unique feature to control gain independently from two different consoles connected to M8-OPT. After enabling Emulation Mode using OPTOCORE CONTROL software; all adjustments such as gain, Phantom power and Pad switches can be set directly from console without any additional control unit or software. Connection between console's Local rack and OPTOCORE NETWORK is made using MADi digital signal, with no additional cables or protocols required.

Additionally Playback System and Intercom Matrix are connected to M8-OPT using optical MADi to exchange audio signals between all devices connected in the network.

DD32R-FX device connected in the ring adds AES connectivity to the system, which can be used for DSP Processor or for loudspeaker management with no additional latency and unnecessary AD/DA conversions.

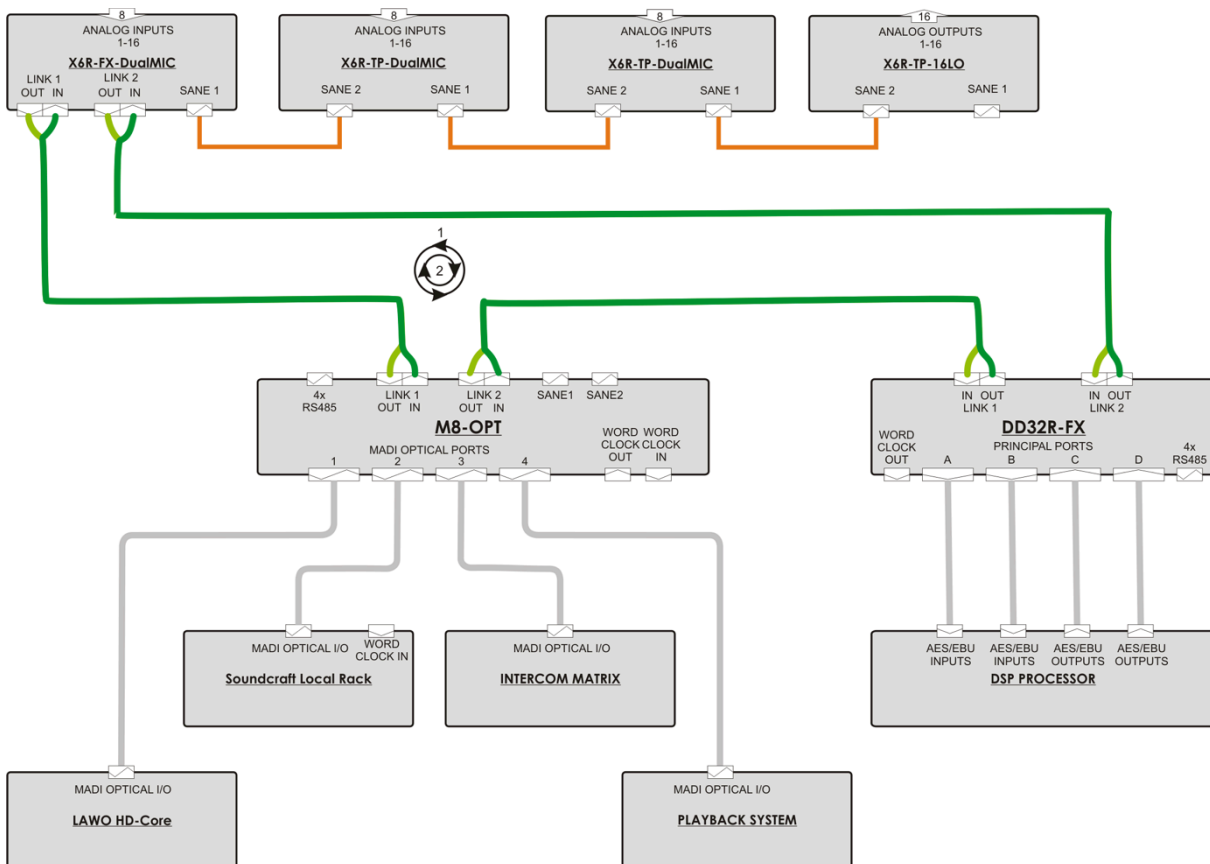
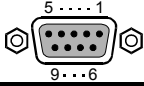

Fig. 4: Redundant network with one M8-OPT, four X6R-series converters and DD32R-FX.

For more details regarding the connecting of 3rd party consoles please refer to Quick Start Guides for each console or Optocore Control Software Manual.

OPTOCORE

Connection Tables

Pin-out		Auxiliary Ports 4 x RS485						
	Channel	RS485				GND	Please assure correct polarity "+" and "-" at both (!) sides / devices when connecting external equipment to the RS485 ports.	
		1	2	3	4			
Pin	+	1	2	3	4	5		
	-	6	7	8	9			
D-Sub-9- female						Locking system acc. to 4-40 UNC		

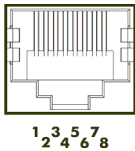
Pin-out		SANE – Synchronous Audio and Ethernet				
	Pin	SANE / "MADI" In	SANE / "MADI" Out	Ethernet In	Ethernet Out	A device compatible with 10/100MB Fast Ethernet can be connected to a SANE port for Ethernet data communication.
		7	4	3	1	
+	7	4	3	1		
-	8	5	6	2		
RJ-45						

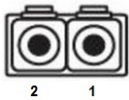
Pin-out		Optical Fibre-Port	
	Pin	Optocore	
		RXD	TXD
		1	2
LC connectors			

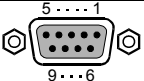
Pin-out		RS232-Port						
	Channel	RS232		Internally Bridged	Power		Use 1-modem cable, male – female, to connect to PC	
		RXD	TXD		+5VS	GND		
Pin		3	2	1, 4, 6	7, 8	9		5
D-Sub-9- female						Locking system acc. to 4-40 UNC		

Pin-out		USB-Port				
	Channel	USB			GND	USB device-connector
		VBUS	D -	D +		
Pin		1	2	3	4	

BI-C Cable

The D-Sub-9 BI-C enables the bi-directional transmission of control data between RS485 connector and Yamaha HA Remote port. The RS485 Ports 3 and 4 of the connector are used.

Auxiliary Port 4 x RS485
X3...X4: I/Os
D-Sub-9-male
Fastening system 4-40 UNC

COM RS422
X3: R x D
X4: T x D
D-Sub-9-female
Fastening system 4-40 UNC

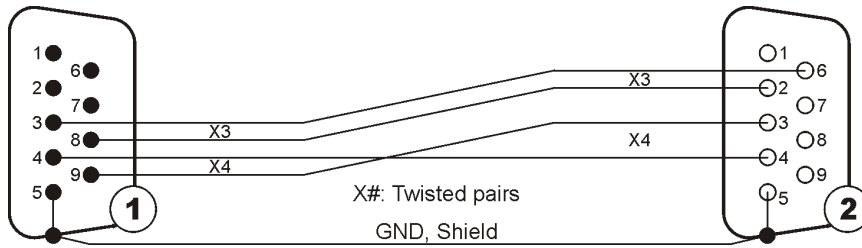

Technical Specifications

MADI Ports		Convention AES10-1991 / AES10-2003	
M12-BNC – EIGHT BNC			
Inputs	Number / Connectors	8 / coaxial	
	MADI digital audio channels	56 or 64 per Input	
Outputs	Number / Connectors	8 / coaxial	
	MADI digital audio channels	56 or 64 per Output	
Data rate	125 Mbps		
Impedance	Termination	75 Ω	
M12-OPT – EIGHT OPTICAL SC			
Inputs	Number / Connectors	8 / optical SC Multimode	
	MADI digital audio channels	56 or 64 per Input	
Outputs	Number / Connectors	8 / optical SC Multimode	
	MADI digital audio channels	56 or 64 per Output	
Data rate / Wave length	125 Mbps / 1310 nm (typical)		
Max. cable length	50/125 µm	1500m / 5000 ft.	
M12-OPT/BNC – FOUR OPTICAL SC / FOUR BNC			
Inputs	Number / Connectors	4 / coaxial 4 / optical SC multimode	
	MADI digital audio channels	56 or 64 per Input	
Outputs	Number / Connectors	4 / coaxial 4 / optical SC multimode	
	MADI digital audio channels	56 or 64 per Output	
M8-BNC – FOUR BNC			
Inputs	Number / Connectors	4 / coaxial	
	MADI digital audio channels	56 or 64 per Input	
Outputs	Number / Connectors	4 / coaxial	
	MADI digital audio channels	56 or 64 per Output	
Data rate	125 Mbps		
Impedance	Termination	75 Ω	
M8-OPT – FOUR OPTICAL SC			
Inputs	Number / Connectors	4 / optical SC Multimode	
	MADI digital audio channels	56 or 64 per Input	
Outputs	Number / Connectors	4 / optical SC Multimode	
	MADI digital audio channels	56 or 64 per Output	
Data rate / Wave length	125 Mbps / 1310 nm (typical)		
Max. cable length	50/125 µm	1500m / 5000 ft.	
SANE, LAN ports		Convention	
Audio	TIA - 568A/B, Optocore	200 Mbit/s	
LAN	TIA - 568A/B, IEEE - 802.3	10/100 Mbit/s	
Auxiliary Ports		Convention EIA / TIA-485	
Data channels	Digital control data	4	
Data rate	Up to 10 Mbps		
Impedance	Termination	330 Ω	
	Source	≤ 10 Ω	
Word clock		Hardware standard 75 Ω / BNC	
Data rate	Depending on selected sample rate	Up to 192 kHz	
Impedance	Output	≤ 5 Ω	
	Input	75 Ω	
Drive level	Output	≥ 1 V _{pp}	
Zero level	Referring to GND		
Sense level	Input	≥ 400 mV _{pp}	
Optical Connection		Complies with 21 CFR 1040.10 and 1040.11	
Remote Control		Convention	
RS232	EIA / TIA - 232	57 600 Baud	
USB Port	USB 2.0 - Device		
LAN	TIA-568A/B, IEEE - 802.3	10/100 Mbit/s	
Power supply		2 independent power supplies with function check and automatic switch-over	
Type	Switch-mode, universal input		
Mains voltage	100 ... 240 V		
Frequency	50 ... 60 Hz		
Power consumption	Depending on device, 32VA – Max		
Security classification	Class 1: basic insulation, connected to the protective grounding conductor		
Security regulations	Harmonised European standard EN60065		
Mains connector	acc. to IEC-950		
Cooling	Passive, via surface and ventilation-slits on both sides		

Dimensions and Weight

Front panel: width 483 mm / 19 inch
 height 44 mm / 1.73 inch
 depth 200 mm / 7.87 inch

Rear panel: width 438 mm / 17.25 inch

Weight

M8-OPT, M8-BNC: 2.70 kg \approx 6.0 lbs

M12-OPT, M12-BNC, M12-OPT/BNC: 2.83 kg \approx 6.2 lbs

Please note:

Modifications that serve the purpose of technical improvement may be carried out without prior notification.

Warranty and Liability

Summary of Warranty

OPTOCORE M-Series device is warranted against defects in material and workmanship for 60 months (5 years) from the date of purchase. This warranty does not include mechanical damages caused by misuse. This warranty covers the original registered purchaser only and is not transferable. This warranty does not apply to devices which have been purchased in used condition or demonstrator equipment.

OPTOCORE will, at its discretion, repair or replace a defective product, providing that the defect has occurred under normal operating conditions.

This warranty does not cover damage from acts of God, accident, abuse, neglect, contamination, unauthorised modification, misuse, or operation outside of the environmental specifications for the product, improper site preparation or maintenance, or abnormal conditions of handling. This would include over-voltage failures, and conditions outside of the products specified ratings, problems with customer-supplied software or interfacing, or normal wear and tear of mechanical components. OPTOCORE will acknowledge the evaluation of warranty after inspection.

Not covered by this warranty are defects arising from electromagnetic or electrical interferences, deficiency, excess, or surge of electrical supply, air conditioning, or humidity. This also includes repairs made necessary by dirt, abrasion, moisture, rust, corrosion, or similar conditions.

Devices on which the Serial Number has been removed or defaced are not eligible for warranty service.

OPTOCORE devices contain no user-serviceable components: refer to qualified service personnel for repair or upgrade. The warranty will be void if you tamper with internal components. Please address any questions or inquiries to OPTOCORE or your distributor/dealer.

For a full warranty conditions refer to the Warranty Card attached to every Optocore device with a first shipment.

How to Obtain Warranty Service

When discovering a problem with an OPTOCORE device, you should contact either Optocore directly or a dealer/distributor to determine and confirm a hardware fault. If it is a software issue the hardware must not be returned to OPTOCORE, OPTOCORE will issue a support ticket in this case.

If hardware service is required within the warranty period, take the equipment, along with warranty card, to the nearest authorised OPTOCORE dealer/distributor. The dealer/distributor will make sure that the device is serviced according to the terms of warranty by OPTOCORE or an authorised service centre.

If the equipment needs to be returned directly to OPTOCORE, first contact support@optocore.com.

OPTOCORE requires the serial number of the equipment intended for return, as well as a short description of the problem. If possible, you should also provide us a phone number where you can be reached during regular working hours. To return a defective product, please contact your distributor / dealer. Our web site: <http://www.optocore.com/> provides a complete list of Optocore distributors / dealers.

Make sure the equipment being returned is packed carefully to protect it from damage during shipment. OPTOCORE requires that shipments are pre-paid and insured – unless specifically authorized in advance.

We strongly advise not to use simple flight-cases without rack-in-rack mounting.

Declaration of Liability

Optocore accepts no liability for damage caused to other devices through operation of the M-Series device.

Optocore is not liable for any damage caused by shipping accidents, misuse, abuse, operation with incorrect AC voltage, operation with faulty peripheral equipment, or improper or careless installation of the device.

Neither OPTOCORE nor anyone involved in the production of the equipment shall be liable for any indirect, special, disciplinary, consequential, or incidental damages arising out of the use or inability to use this equipment even if OPTOCORE has been advised of the possibility of such damages. In no event shall the liability of OPTOCORE exceed the purchase price of any defective equipment.

Optocore accepts no claims for compensation whatsoever (e.g. cancellation of events).

Shipping Contents

The standard shipment of a M-Series unit contains the following:

- 1 M-Series unit
- 1 fiber patch cable LC-LC
- 2 power cables

Any additionally purchased equipment such as optical wave-guide cables in required lengths, D-Sub cables and adapters, RS232 cables, and international electric cables, which have been supplied on your request and your purchase order, cannot be listed above.

Please note that due to the Ecology reason standard shipment **does not** contain printed copy of User Manual. All latest OPTOCORE user manuals can be downloaded from the website:

<http://www.optocore.com/index.php/support/downloads>

Printed version of User Manual is available on a special demand. Please contact support@optocore.com if printed version is required.

Company Information

Mailing Address:

OPTOCORE GmbH
Lohenstr. 8
D-82166 Munich-Gräfelfing
Germany

Telephone:

+49 – (0)89 – 8999640

Fax:

+49 – (0)89 – 89996455

Internet:

www.optocore.com

Email:

inquiry@optocore.com