



KU4 Owner's Manual

INTRODUCTION

Unless you have used an original RCA KU3A (also known by its manufacturing number M-10001), the new AEA KU4 is unlike any ribbon microphone you have ever experienced. This is due, in part, to its unique supercardioid polar pattern. Designed in the late 1940s to fulfill the uncompromising demands of the Hollywood movie studios, the KU3A was RCA's most expensive ribbon microphone, and many engineers consider it to be the best unidirectional ribbon microphone ever made. Fewer than 600 were manufactured, and those that remain in existence are highly prized for their sensitivity, their rich lower midrange, and their surprisingly strong high-frequency presence.

What made the KU3A so special? Based on the smooth long-ribbon sound of RCA's classic model 44BX, the KU3A provided a unidirectional, rather than a bi-polar, response pattern. In contrast to the RCA 77-D(X), the KU3A had a fixed pattern. Thus, RCA was able to improve the polar response as a function of frequency by optimizing the shape of the ribbon motor and by fine-tuning the acoustic design of the microphone. With its wider sweet spot and reduced proximity bass boost, it expanded the recording engineer's range of placement options making it a standard for location sound, film scoring, and recording studios around the world.

By the end of the 1960s, condenser (capacitor) microphones had become the new standard throughout the recording industry, replacing their bulkier and more fragile ribbon ancestors. Nonetheless, ribbon microphones - both old and new - are highly valued for their sonic characteristics by experienced music recording engineers and remain in daily use. Because the KU3A is a rare collector's item, few studios or rental houses own them, so opportunities to work with a good KU3A are limited.

Following our tradition of providing "reincarnations" of the original RCA microphones, AEA is proud to introduce the new AEA KU4 studio ribbon microphone, featuring new-old-stock (NOS) RCA ribbon material, parts interchangeable with the original KU3A, and the consistent and reliable performance for which our microphones have gained a world-wide reputation.

QUICK-START GUIDE

To maintain the best performance from your new AEA KU4 microphone, take note of these five basic rules:

- 1) Keep the microphone covered when it is not in use.
- 2) Always use a sturdy microphone stand or a boom with a counterweight.
- 3) Never apply phantom power to the microphone.
- 4) Never expose the microphone to strong air turbulence.
- 5) Be nice to the microphone, and it will be nice to you.

1) Keeping the microphone covered when it is not in use will reduce the possibility of damage that might result from a sudden gust of air coming from air-conditioning or an open door or window. Place the supplied twill zipper bag (or a standard plastic bag) over the microphone when it is not in use. For longer-term storage, replace the microphone in its protective case, and store it vertically.

2) The KU4 weighs slightly under five pounds and is one of the heavier microphones you will ever use. Mounting the microphone on a strong, sturdy microphone stand with a heavy base (or tripod) is essential. If you are using a boom, it also must be strong and provided with an appropriate counterweight to prevent tipping. Conventional “baby-boom” arms are not recommended.

3) In a perfect world, phantom power will not cause damage to a ribbon microphone. However, in our imperfect world, all it takes is a momentary imbalance in the voltage between Pins 2 and 3 to put a DC pulse across the microphone’s output. This almost always destroys or severely damages the ribbon.

4) Ribbon microphones can withstand very high SPL without difficulty, but can be damaged easily by a sudden, strong gust of air. This can stretch the ribbon, causing the microphone to lose sensitivity and distort its frequency response. To avoid possible damage, follow this simple procedure when positioning the microphone. Put the back of your hand where the mic will be; if you can feel the motion of air on your hand, place a Popper Stopper™ or similar protective popscreen between the microphone and the source of the air turbulence.

5) Your KU4 is a valuable and important investment. Like any microphone, it requires common sense and good basic care to keep it working properly. Unlike most condenser microphones, however, there are no electronic parts that can deteriorate with age. Given simple, basic care as described above, your new microphone will perform admirably for decades.

HOW IS THE KU4 DIFFERENT FROM OTHER RIBBON MICROPHONES?

All ribbon microphones are dynamic pressure-gradient transducers. They respond to the difference in pressure between the front and back of the ribbon. As soundwaves move the ribbon in the magnetic field the ribbon generates a small current directly in response to the velocity of its movement. Thus, it needs no internal electronics.

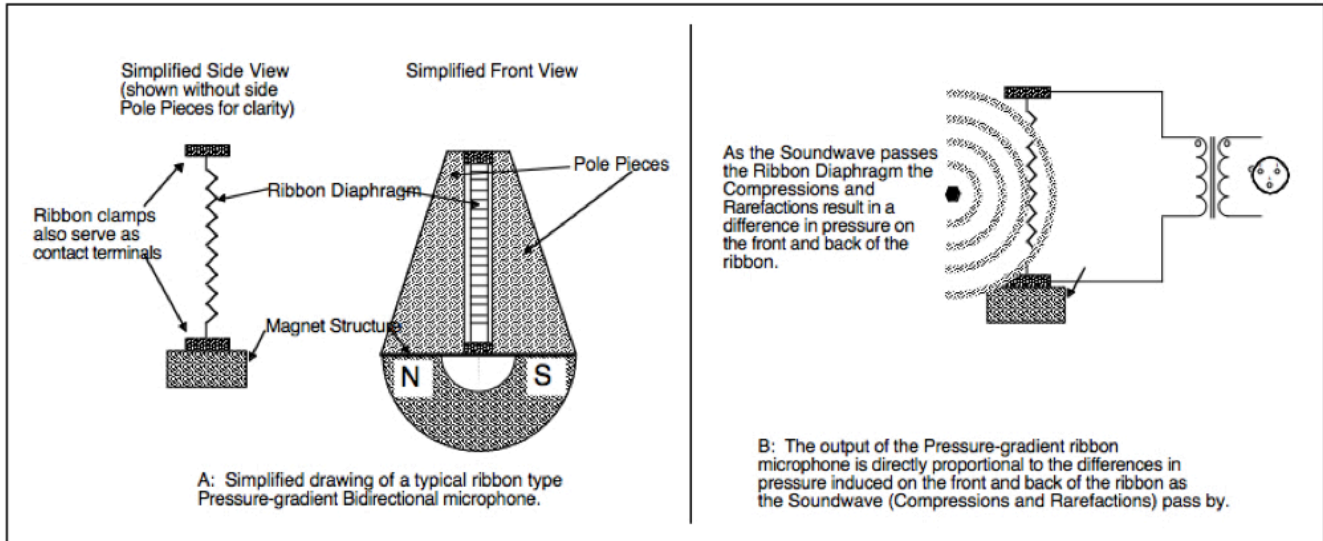

With all conventional ribbon microphones soundwaves approaching the microphone directly from either the front or the back will be picked-up with equal sensitivity. The only difference will be the absolute polarity of the electrical output: sounds arriving from the back will produce polarity opposite to those arriving from the front. These bidirectional microphones are characterized by this two-sided response, commonly called “figure-of-eight”, because of the obvious shape of their polar pattern as illustrated below. The off-axis response follows a cosine law, producing a minimum pickup “null plane” at $\pm 90^\circ$.

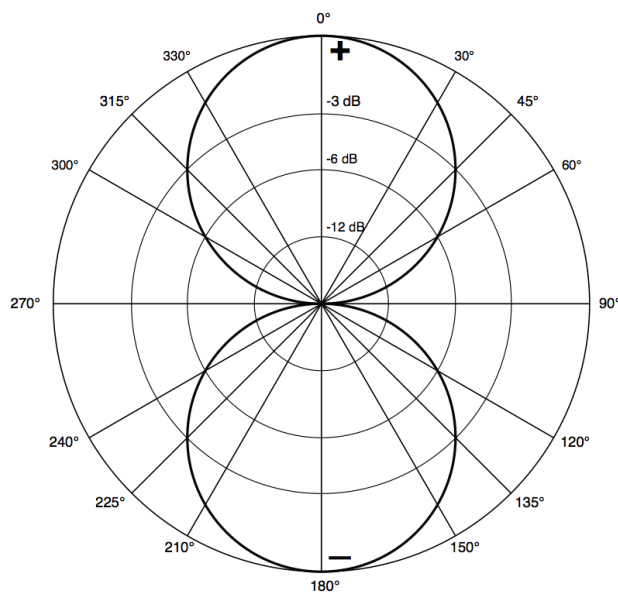

The AEA KU4 is unlike any other ribbon microphone, because its polar response has been tailored to provide a supercardioid pickup pattern.

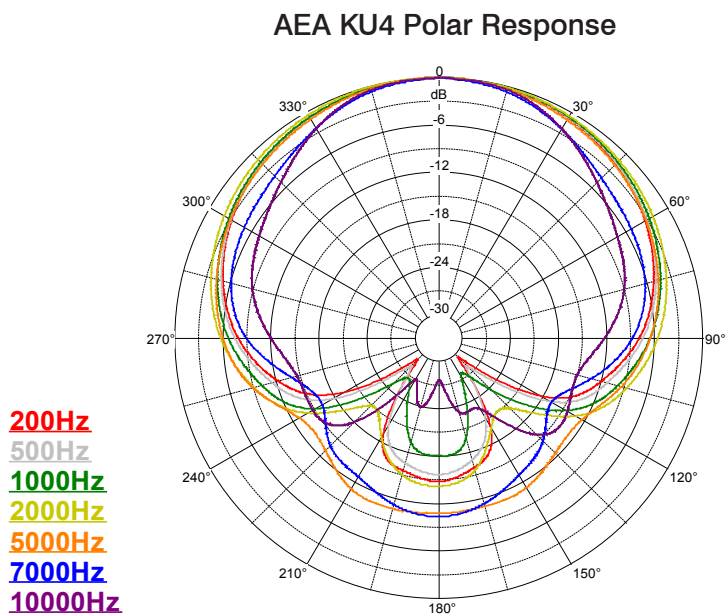

The reduced rear-lobe of the supercardioid pattern means that compared to a conventional bi-directional ribbon microphone, the KU4 will have less pickup of ambient noise or other sounds approaching from the rear. This makes it much easier to use in situations where isolation between instruments is important.

Conventional ribbon microphones exhibit a significant proximity effect when used close to the sound source. While this gives a characteristic warmth and richness to their sound, it also can cause problems by unnaturally exaggerating the low-frequency pickup of certain voices or instruments. The KU4 has been designed to reduce proximity bass boost to facilitate closer mic placement. At the same time its low-tuned ribbon delivers solid, undistorted bass. These characteristics make the KU4 well suited for modern studio music production, and ideal for low strings and brass instruments as well as vocals.

At the opposite end of the frequency spectrum, the KU4's lightly-tensioned, ultra low mass ribbon produces response out to 40 kHz with fast, accurate transients, and without the upper-midrange ringing common to condenser microphones.

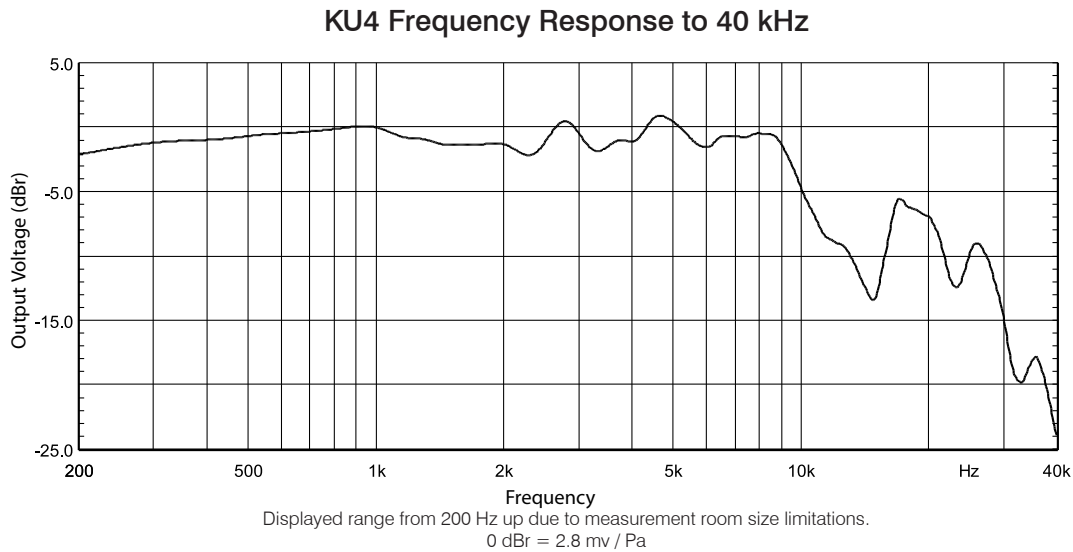

To provide the utmost in long-term reliability, the KU4's ribbon is well protected from external damage and its field-tech replaceable pole piece and ribbon assembly enable convenient repair if damage occurs to the microphone.

HOW IS THE KU4 DIFFERENT FROM THE ORIGINAL KU3A?

The KU4 is a modern interpretation of the classic KU3A. It shares the same sonic qualities for which the RCA original is renowned. Several parts of the microphones are interchangeable, such as the grill basket and the yoke, but the AEA KU4 also features various improvements over the KU3A. Most importantly, AEA has focused on utilizing contemporary manufacturing science to improve the consistency of the materials, construction, and hence the sound from unit to unit. This allows us to ensure the quality that is AEA's hallmark, and to offer a matched-pair option at low cost. The construction of the ribbon motor itself has been completely changed in order to allow the pole piece assembly to be replaced by a trained technician.

As pointed out above, original KU3A microphones were not very consistent from unit to unit. Original RCA documents specified a cardioid pick-up pattern. In our experience, only very few KU3As actually have a true cardioid pattern, and the performance can vary significantly between two units. We have found that we can accomplish the best compromise between on-axis sound and consistency in polar pattern by choosing a supercardioid characteristic.

Many different shock mounts were used on the original KU3As. Every major film studio would design its own shock mount. These shock mounts were often very bulky and needed frequent maintenance. A few original KU3As were equipped with the RCA 44-style yoke and cushion mount. AEA considers this a very elegant solution that also reduces some of the bulkiness of the microphone for ease of use and positioning in modern music production. Since the KU4 is not likely to be used as a boom microphone anymore, there is no need for the extreme vibration isolation of those early shock mounts. The AEA cushion mount has been successfully used on the R44 series microphones for many years and is therefore a good match.

GENERAL GUIDELINES FOR USING THE AEA KU4

Controlling Leakage

A significant and ever-present challenge in contemporary studio recording is minimizing “leakage” from nearby instruments into the various microphones. The deep nulls of ribbon microphones provide good rejection of unwanted sounds, which also can be beneficial in sound reinforcement situations where “feedback” is always a threat. While “gobos” can be effective in isolating performers from each other, they introduce their own set of problems - not the least of which are reflections in close proximity to the performers and/or microphones that result in comb-filter distortions. Because gobos usually are bulky and occupy valuable floor space, they also inhibit the ability of the musicians to hear and see each other easily. Such a setup requires complex and often cumbersome headphone monitor mixes for the musicians.

Because the KU4 has a supercardioid pattern, it has nulls at approximately $\pm 135^\circ$ from the principal (front) axis. Projected in three dimensions, these nulls produce a “cone of rejection” to the rear of the microphone that can be used effectively to reduce leakage. Simply arrange the musicians so that nearby instruments are placed in the “null” of their neighbor’s microphone, and vice versa. Although this does not entirely eliminate the need for gobos, it can significantly reduce their number.

Proximity effect

Proximity effect is a characteristic of all directional microphones; it is a rising low-frequency response at closer working distances. While this can be used to good effect, particularly with male voices to give them an enhanced richness and depth, the potential tradeoff is reduced articulation or clarity that can result from the masking effect on the treble due to “excessive” bass response.

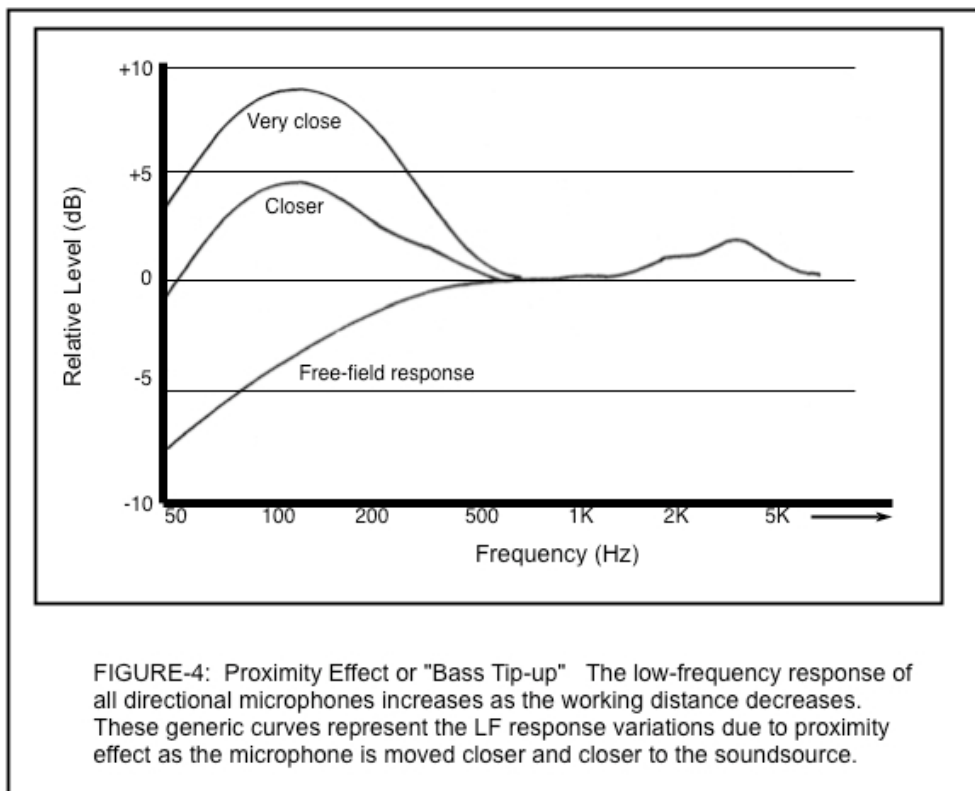

Experienced vocalists instinctively locate the proper working distances for the microphones they are using. From as early as the 1930s, Frank Sinatra always kept one hand on the microphone stand while singing. Some joked that he simply was steadying himself, but more knowledgeable people noticed that he would bring the mic closer for more intimate moments, and then move it farther away when he belted out a line. This technique became known as “working the mic.”

A simple technique for maintaining the proper working distance from the microphone is to place a popscreen between the performer and the microphone. By doing this, nothing need be said to the performers as they naturally will work at the distance you have established.

The DO's and DON'Ts of Ribbon Microphones

Because they have no internal electronic components or power supply to degrade with age, ribbon microphones need little, if any, maintenance. Given proper care they last for decades. Bing Crosby's personal RCA-44BX (now in the collection of the Pacific Pioneer Broadcasters in Hollywood) sounds as good today as it did when he recorded his radio broadcasts in the 1940s.

A few simple precautions will help you to keep your AEA KU4 working well for life:

... Beware the Power Play

The first, and perhaps most important rule with ribbon microphones is “Don't connect them to a powered input.” Either phantom or T-power can instantly make a ribbon diaphragm resemble a blown fuse! With T-power (a remote powering system where a 12VDC differential exists between pins 2 and 3 of the conventional XLR input connector) this damage is guaranteed. With phantom power systems (where there is supposed to be no voltage potential between pins 2 and 3) if everything is in perfect order, there will be no problems. However, all it takes is a poor cable, a loose connector, an intermittent solder connection, or even just some corrosion on the pins of the connector to create a slight differential voltage, just enough to damage a ribbon microphone. Also, patching a passive ribbon mic on a TT-patchbay while phantom power is engaged will most likely damage the ribbon. Therefore, it is strongly recommended that any powering on a microphone preamplifier input be turned-off for about three minutes before a ribbon microphone is connected. This will allow sufficient time for the preamp's internal blocking capacitors to discharge fully.

... Don't Blow It

A second and equally important rule is never to blow directly into a ribbon microphone to test it. Strong air turbulence can stretch the ribbon diaphragm and while it may not break, it will nonetheless significantly degrade the microphone's performance. **The “rule at hand” for positioning any ribbon microphone is to use the back of your hand:** If you can feel the air motion on the back of your hand, don't put the mic there unless you first provide some form of wind protection, such as a Popper Stopper TM. Obviously, use out of doors requires special care so that the wind does not damage the ribbon. Indoors, however, it is also important to avoid air turbulence: open windows, air-conditioning systems, or even rapid movement of the microphone, such as carrying it about or panning the mic on a studio boom, all can be sufficient to stretch the ribbon.

High SPL sound sources do not usually pose a problem because most ribbon microphones can handle 130 dB/SPL or more without difficulty. It is only those “explosive” sources that produce a strong blast of air, such as the bass port on an electric guitar or bass amp, a guitar being plugged (or unplugged) while the amp level is turned fully up, an on-axis kick-drum (particularly with a port on the front head), or even a very close talking or singing voice with a lot of plosive sounds, that require special protection. Again, just apply the “back of the hand” test.

If the microphone is stored in a cabinet or box, do not slam the door. This strong acoustical pressure impulse could be sufficient to stretch the ribbon.

... “Tramp Iron”

Remember also that most ribbon microphones contain a magnet that produces a fairly strong magnetic field. This field can attract any ferric objects near the microphone that, if they are small enough, can penetrate the outer screening and work their way inside the microphone. Minute iron particles, sometimes known as “tramp iron,” exist everywhere within our environment. When in close proximity to a ribbon microphone, these can be drawn inside and over time can build-up sufficiently in the magnetic gap to rub against the ribbon, causing distortion or electrical shorts. The best prevention is to keep the microphone covered with a plastic bag (or the custom-made cotton twill bag available as an accessory from AEA) when it is not in use. This simple procedure also protects the microphone from the air blast problems discussed above. Under no circumstances should you take the grill off of the microphone as this could allow tramp iron to enter the narrow gap between the ribbon and the pole pieces.

... Keep It Up

When storing the microphone, common sense is all that is needed to protect it from excessive mechanical shock and air turbulence. When long ribbon microphones are left in storage for extended periods of time it is a good idea to keep the mic upright so that the ribbon is vertical. This will minimize the tendency of the ribbon to “sag” due to the pull of gravity. Although there is no scientific evidence supporting this theory, we know that experienced “old-time” engineers store their ribbon mics vertically.

... Provide proper support for the microphone

Common 10-lb. round-base microphones stands are just fine if you are working with a Shure SM58. Heavier ribbon microphones, such as the AEA R77, R84, or your new KU4 need sturdy support. Many manufacturers provide heavy, solid-based stands (e.g. the Atlas MS 20 or MS 25) or portable tripod stands with a wide effective diameter. Similarly, if you are using a boom, you need something heavier and more reliable than a “baby boom.” Large studio-booms with an appropriate counter-weight are recommended to prevent your KU4 from tipping-over and crashing, causing injury to itself, a musician, or a valuable musical instrument.

...Position the microphone properly

The integrated cushion mount of the microphone was designed to keep structure-borne noise transmitted through the microphone stand and the cable away from the low-tuned ribbon transducer. For the shock mount to function as intended, it is important to position the microphone with the cushion mount vertical and rotating the microphone within the u-shaped yoke. This requires the use of a swivel mount when using a boom arm for positioning the microphone in a vertical configuration. Hav-

ing the cushion mount reaching out horizontally on a boom will cause inferior vibration isolation and can also distort the cushion mount as time goes by.

... Stay away from hard drives

The high-performance magnets used in the KU4 are incredibly strong and a significant amount of stray magnetic field lines surround the microphone. Avoid placing the microphone in close proximity to hard drives, credit cards, analog tape, or any other magnetically-sensitive items to prevent any data loss.

GUIDELINES FOR USING THE AEA KU4 FOR SPECIFIC APPLICATIONS

Obviously your ears are the best judge of microphone choice and placement. However, AEA has garnered a great deal of experience testing the KU4 in a variety of recording settings and talking to experienced users of the original KU3A. As a result we suggest the following guidelines to help you to achieve optimum results when using the KU4.

Vocals

Our experience with the KU4 is that it sounds best on vocals when used at a distance between 6 - 12 inches. However, you may find that positioning the microphone closer or further away from the singer yields better results depending on the voice, the room or the musical style. When recording at 6 inches or closer, it is advisable to have a pop filter handy. (Remember the “back-of-the-hand” test.) Make sure you monitor the recording at an appropriate listening level so that excessive low-frequency plosives do not slip by unnoticed.

The microphone has a vertical sweet spot that sits slightly above the horizontal fold of the front grill. When positioning the microphone, choose an appropriate stand or boom setup to accommodate for the height of the vocal talent in order to achieve the best sound. Every singer will move a bit while performing, but since the sweet spot is located in both the horizontal and vertical axes it is fairly wide and forgiving.

The suppressed rear lobe of your KU4 can be very useful when recording in small booths or under less than ideal acoustics. The angles of maximum off-axis sound rejection are at $\pm 135^\circ$, and you can use those angles effectively to minimize reflections caused by nearby booth windows or walls.

Brass

Passive ribbon microphones and particularly the original KU3A are known for the excellent qualities when recording brass instruments. The smooth high frequency response of ribbon microphones complements the sound of brass instruments that can often get harsh and edgy when recorded with condenser microphones.

Although ribbon microphones are sensitive to air blasts they can nevertheless handle high SPL (sound pressure level). In fact, the absence of electronics and the high maximum SPL value make passive ribbon microphones ideally suited for recording brass, which can get extremely loud but do not output any wind. With low register brass instruments such as bass trombones or tuba you might still want to use the “back-of-the-hand” test to make sure that you remain on the safe side. Depending on the player, you should be able to use distances between 1-2 feet to get a good result. If the player is very loud, rotate the microphone slightly so the bell of the instrument is not aiming straight at the ribbon.

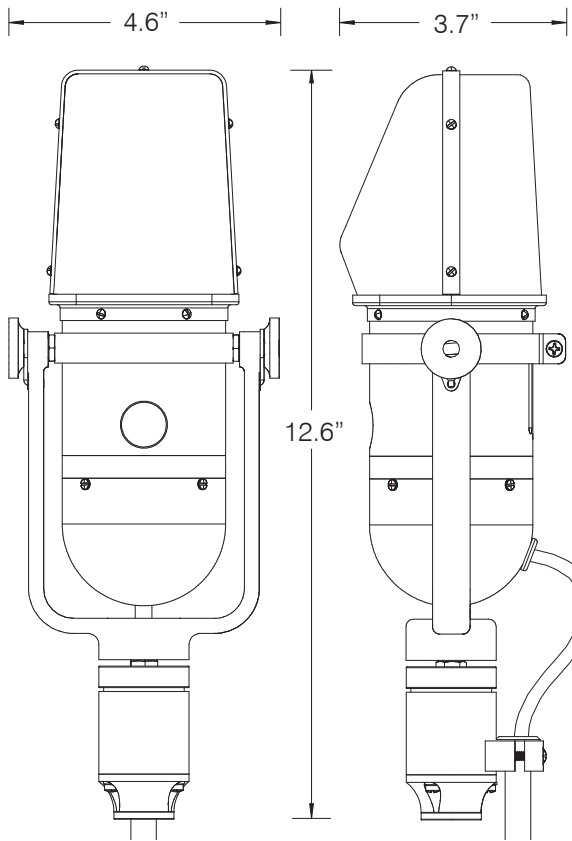

Specifications:

Operating Principle: Velocity microphone

- Frequency Response: Below 30 Hz to above 20 kHz
- Maximum SPL: 140 + dB SPL above 200Hz for 1% third harmonic
- Output Sensitivity: 2.5 mV/Pa into unloaded circuit
- Output Impedance: 300 Ω nominal
- Recommended Load: 10 k Ω or greater
- Phantom power: Not required or recommended
- Polarity: Pin 2 high for positive pressure at the front of the microphone.
- Connector: XLR-3M wired to a 3 meter captive cable

Off Axis Response:

- Polar Pattern: Supercardioid
- Relative Output at 180° (dB): -12
- Angle of Maximum Rejection: 135°

Transducer element

- Ribbon Thickness: 1.8 microns (.0000018 meter) of pure aluminum
- Ribbon Width: 0.082" (2.1 mm)
- Ribbon Length: 1.25" (28.6 mm)

Accessories:

- Included: Custom storage/shipping case, stand adapter, manual, gray twill zippered bag, and attached 3 meter microphone cable.

Limited Warranty:

- Three years parts and labor, shipping not included.

KU4 weight with cable: 4.7 pounds (2.15 kg)
 KU4 weight with case: 7 pounds (3.2 kg)
 Length: 12.65" (32.4 cm) Width: 4.62" (11.7 cm)
 Depth: 3.75" (9.5 cm)

Options

M Hand tuning to stereo match a pair

Accessories

- B Gray twill zippered bag (included)
- AD-1 5/8"-27 F stand adapter to 1/2"-NPS M (included)
- 44VC Vertical carry case for one (included)
- 44VC-2 Vertical carry case for two

KU4 Frequency Response to 40 kHz

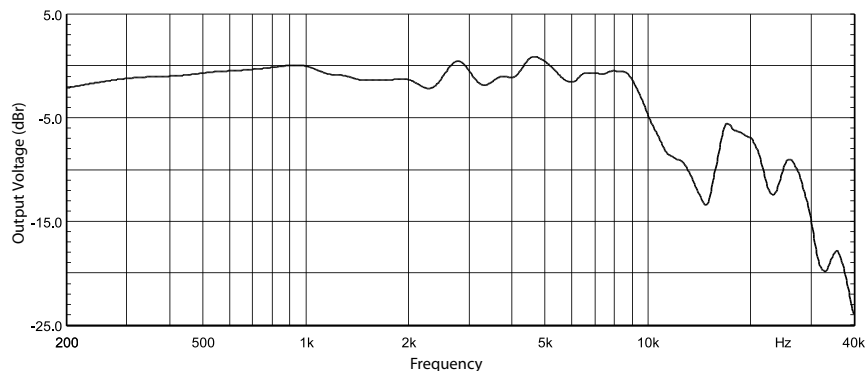

Displayed range from 200 Hz up due to measurement room size limitations.
 0 dBr = 2.8 mv / Pa